



Simply Better Connections

CS1942ATC

2-Port USB 3.0 4K Dual Display
DisplayPort KVM™ Switch for ATC
User Manual

Compliance Statements

FEDERAL COMMUNICATIONS COMMISSION INTERFERENCE STATEMENT

This equipment has been tested and found to comply with the limits for a Class A digital device, pursuant to Part 15 of the FCC Rules. These limits are designed to provide reasonable protection against harmful interference when the equipment is operated in a commercial environment. This equipment generates, uses, and can radiate radio frequency energy and, if not installed and used in accordance with the instruction manual, may cause harmful interference to radio communications. Operation of this equipment in a residential area is likely to cause harmful interference in which case the user will be required to correct the interference at his own expense.

The device complies with Part 15 of the FCC Rules. Operation is subject to the following two conditions: (1) this device may not cause harmful interference, and (2) this device must accept any interference received, including interference that may cause undesired operation.

FCC Caution

Any changes or modifications not expressly approved by the party responsible for compliance could void the user's authority to operate this equipment.

Warning

Operation of this equipment in a residential environment could cause radio interference.

Achtung

Der Gebrauch dieses Geräts in Wohnumgebung kann Funkstörungen verursachen.



KCC Statement

유선 제품용 / A 급 기기 (업무용 방송 통신 기기)
이 기기는 업무용 (A 급) 전자파적합기기로서 판매자 또는 사용자는 이
점을 주의하시기 바라며, 가정 외의 지역에서 사용하는 것을 목적으로
합니다.

Industry Canada Statement

This Class A digital apparatus complies with Canadian ICES-003.

CAN ICES-003 (A) / NMB-003 (A)

RoHS

This product is RoHS compliant.

User Information

Online Registration

Be sure to register your product at our online support center:

International	http://eservice.aten.com
---------------	---

Telephone Support

For telephone support, call this number:

International	886-2-8692-6959
China	86-400-810-0-810
Japan	81-3-5615-5811
Korea	82-2-467-6789
North America	1-888-999-ATEN ext 4988 1-949-428-1111

User Notice

All information, documentation, and specifications contained in this manual are subject to change without prior notification by the manufacturer. The manufacturer makes no representations or warranties, either expressed or implied, with respect to the contents hereof and specifically disclaims any warranties as to merchantability or fitness for any particular purpose. Any of the manufacturer's software described in this manual is sold or licensed *as is*. Should the programs prove defective following their purchase, the buyer (and not the manufacturer, its distributor, or its dealer), assumes the entire cost of all necessary servicing, repair and any incidental or consequential damages resulting from any defect in the software.

The manufacturer of this system is not responsible for any radio and/or TV interference caused by unauthorized modifications to this device. It is the responsibility of the user to correct such interference.

The manufacturer is not responsible for any damage incurred in the operation of this system if the correct operational voltage setting was not selected prior to operation. PLEASE VERIFY THAT THE VOLTAGE SETTING IS CORRECT BEFORE USE.

Product Information

For information about all ATEN products and how they can help you connect without limits, visit ATEN on the Web or contact an ATEN Authorized Reseller. Visit ATEN on the Web for a list of locations and telephone numbers:

International	http://www.aten.com
North America	http://www.aten-usa.com

Package Contents

Check to make sure that all the components are in working order. If you encounter any problem, please contact your dealer.

The CS1942ATC package consists of:

- ◆ 1 CS1942ATC 2-Port USB 3.0 4K Dual Display DisplayPort KVMPTM Switch for ATC
- ◆ 4 DisplayPort 1.2 cables*
- ◆ 2 USB 3.1 Type-A to Type-B cables
- ◆ 2 microphone cables
- ◆ 2 speaker cables
- ◆ 2 power adapters and power cords
- ◆ 1 user instructions

Note: The high quality DisplayPort cables included in this package (or cable of equal standards) are required to achieve 4K video resolutions.

Contents

Compliance Statements	ii
User Information	iv
Online Registration	iv
Telephone Support	iv
User Notice	iv
Product Information	v
Package Contents	vi
Contents	vii
About this Manual	x
Conventions	xi
1. Introduction	
Overview	1
Features	2
Requirements	3
Console	3
Computers	3
Cables	3
Operating Systems	4
Components	5
CS1942ATC Front View	5
CS1942ATC Rear View	5
2. Hardware Setup	
Cable Connections	9
Installation Diagram	11
3. Basic Operation	
Port Switching	13
Manual Switching	13
Mouse Switching	14
RS-232 Commands	14
Remote Port Selector (Optional)	14
Hot Plugging	14
Powering Off and Restarting	14
Port ID Numbering	15
Alternative Manual Port Selection Settings	15
4. Hotkey Operation	
Hotkey Port Switching	17
Cycling Through the Ports	17
Going Directly to a Port	17
Hotkey Setting Mode	18

Invoking HSM	18
Alternate HSM Invocation Keys	19
Buzzer Control	19
Power Redundancy Indication	19
Pause Power Redundancy Indication	20
Keyboard Operating Platform	20
List Switch Settings	21
USB Reset	21
Keyboard Language	21
Firmware Upgrade Mode	21
Restore Default Settings	22
Alternative Manual Port Selection	22
Mouse Emulation	22
Mouse Port Switching	22
Keyboard Emulation	23
Power on Detection	23
N-Key Rollover Keyboard Supporting Function	23
EDID Mode	24
HSM Summary Table	25

5. Keyboard Emulation

Mac Keyboard	27
Sun Keyboard	28

6. RS-232 Operation

Overview	29
Setup	29
Hardware Connection	29
RS-232 Pin Assignments	30
Console Login - HyperTerminal	31
RS-232 Commands	32
Verification	32
Open / Close	33
Formulas:	33
Parameters:	33
Open/Close RS-232 Link Command	33
Switch Port	34
Formula:	34
Parameters:	34
Switch Port Commands	34
Set Baud Rate	35
Formula:	35
Parameters:	35
Set Baud Rate Commands	35
Keyboard Language Layout	36
Formula:	36

Parameters:	36
Keyboard Language Layout Commands	36
Hotkey Setting	37
Formulas:	37
Hotkey Setting Commands	37
USB Reset	38
Formulas:	38
Parameters:	38
USB Reset Command	38
Restore Default Settings	39
Formulas:	39
Parameters:	39
Restore Default Value Command	39
Firmware Upgrade	40
Formulas:	40
Parameters:	40
Firmware Upgrade Command	40
KVM Status	41
Formulas:	41
Parameters:	41
KVM Status Command	41

7. The Firmware Upgrade Utility

Before you Begin	43
Starting the Upgrade	45
Upgrade Succeeded	48
Upgrade Failed	49

Appendix

Safety Instructions	51
Optional Remote Port Selector	52
Troubleshooting	53
Technical Support	54
International	54
North America	54
Specifications	55
Hotkey Default Settings	57
ATEN Standard Warranty Policy	58

About this Manual

This user manual is provided to help you get the most from your CS1942ATC unit. It covers all aspects of installation, configuration and operation. An overview of the information found in the manual is provided below.

Chapter 1, Introduction, introduces you to the CS1942ATC. Its purpose, features and benefits are presented, and its front and back panel components are described.

Chapter 2, Hardware Setup, describes how to set up your installation. The necessary steps are provided.

Chapter 3, Basic Operation, explains the fundamental concepts involved in operating the CS1942ATC.

Chapter 4, Hotkey Operation, details all of the concepts and procedures involved in the Hotkey operation of your CS1942ATC installation.

Chapter 5, Keyboard Emulation, provides tables that list the PC to Mac keyboard emulation mappings.

Chapter 7, The Firmware Upgrade Utility, explains how to upgrade the CS1942ATC's firmware with the latest version available.

Appendix, provides specifications and other technical information regarding the CS1942ATC.

Note:

- ◆ Read this manual thoroughly and follow the installation and operation procedures carefully to prevent any damage to the unit or any connected devices.
 - ◆ The product may be updated, with features and functions added, improved, or removed since the release of this manual. For an up-to-date user manual, visit <http://www.aten.com/global/en/>
-

Conventions

This manual uses the following conventions:

- | | |
|---|--|
| Monospaced | Indicates text that you should key in. |
| [] | Indicates keys you should press. For example, [Enter] means to press the Enter key. If keys need to be chorded, they appear together in the same bracket with a plus sign between them: [Ctrl+Alt]. |
| 1. | Numbered lists represent procedures with sequential steps. |
| ◆ | Bullet lists provide information, but do not involve sequential steps. |
| > | Indicates selecting the option (on a menu or dialog box, for example), that comes next. For example, Start > Run means to open the <i>Start</i> menu, and then select <i>Run</i> . |
|  | Indicates critical information. |

This Page Intentionally Left Blank

Chapter 1

Introduction

Overview

The ATEN CS1942ATC 2-Port USB 3.0 4K DisplayPort Dual Display KVMP™ Switch for ATC is tailor-made for Air Traffic Control scenarios. It supports 2Kx2K resolution, making it perfect for radar monitoring, and also enables constant monitoring of flight information and mission-critical processes. Incorporating dual display capability, users can enjoy a wider screen and easy switch between the two DisplayPort systems.

The Zero-Second Switch function ensures nearly real-time switching without any black screens, providing air traffic controllers instant access to two USB / DisplayPort-interfaced dual display ATC computers for crucial operations. Port switching is flexible via pushbuttons, hotkeys, mouse, RS-232 commands, or an optional accessory the remote port selector.

With two lockable DC jacks for power redundancy, the CS1942ATC ensures uninterrupted operation and constant availability for mission-critical applications. It aims to greatly minimize or eliminate the risk of downtime. Patented ATEN technology – Video DynaSync™, and EDID expert™, combined with DisplayPort 1.2 and video resolutions up to 4K @ 60 Hz, it delivers optimized display resolution with exceptional detail and clarity in all conditions.

The CS1942ATC creates a safer environment and enhanced operational efficiency for Air traffic Control Towers, Approach Control Rooms, and Area Control Centers, specifically tailored the air traffic control industry.

Features

- ◆ One USB / DisplayPort console controls 2 DisplayPort computers and shares 2 USB peripherals
- ◆ Supports 2048 x 2048 @ 60 Hz screen resolutions dedicated for radar monitoring; maximum resolution up to 4096 x 2160 @ 60 Hz
- ◆ Zero-Second Switch – provides continuous video stream and real-time switching
- ◆ Supports power failover – 2 DC jacks for power redundancy to ensure constant availability for mission-critical applications
- ◆ Computer Selection via front panel pushbuttons, hotkeys, mouse, RS-232 commands, and remote port selector
- ◆ Video DynaSync™ – exclusive ATEN technology eliminates boot-up display problems and optimizes resolutions when switching between ports
- ◆ EDID Expert™ – smooth power-up, high-quality display and use of the best video resolution across different screens
- ◆ Supports serial port switching for legacy devices
- ◆ Built-in 2-port USB 3.1 Gen 1 hub with SuperSpeed 5 Gbps data transfer rates
- ◆ DisplayPort 1.2, and HDCP compliant
- ◆ Supports HD audio*
- ◆ Console mouse port emulation / bypass feature supports most mouse drivers and multifunction mice
- ◆ Console keyboard emulation / bypass feature supports most multimedia keyboards
- ◆ Multilingual keyboard mapping – supports English, French, Japanese, and German keyboards
- ◆ Power on detection
- ◆ Auto scan
- ◆ Firmware upgradable

Note: HD audio through DisplayPort cannot be switched independently.

Requirements

Console

- ◆ Two DisplayPort monitors capable of the highest possible resolution
- ◆ A USB mouse
- ◆ A USB keyboard
- ◆ Microphone and speakers

Computers

The following equipment must be available on each computer:

- ◆ Two DisplayPort ports
- ◆ USB Type-A port
- ◆ Audio ports

Cables

To guarantee video quality we recommend using only ATEN DisplayPort KVM cables. Four cables are provided with this package.

-
- Note:** 1. The video quality displayed is affected by the quality and length of the cables you use. We recommend the total length from the source to the monitor not exceed 3 meters. If you need additional cable sets, please contact your dealer to purchase ATEN approved cables.
2. If you use DisplayPort cables that are DP 1.1 compliant, make sure the DisplayPort setting on the monitor is set to auto or DP 1.1.
-

Operating Systems

OS		Version
Windows		2K / XP / 2003 / 2008 / Vista (x64 / x86) / 7 / 10 or above
Linux	RedHat	9.0, Fedora and higher, RHEL AS 4, RHEL 5
	SuSE	10 / 11.1 and higher; OpenSUSE 10.2; SLES 10 SP1
	Debian	3.1 / 4.0
	Ubuntu	7.04 / 7.10 or later
Unix	IBM AIX	4.3 / 5L (V5.2, V5.3) / V6 (V6.1)
	FreeBSD	5.5 / 6.1 / 6.2
	Novell	Netware 6.0 / 6.5
Mac	OS	10.1 / 10.2 / 10.3 / 10.4 / 10.5 / 10.7 / 10.8 or later

Components

CS1942ATC Front View

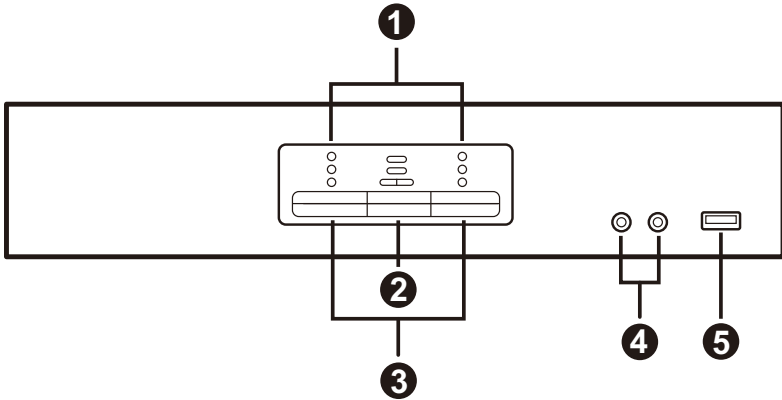

CS1942ATC Rear View

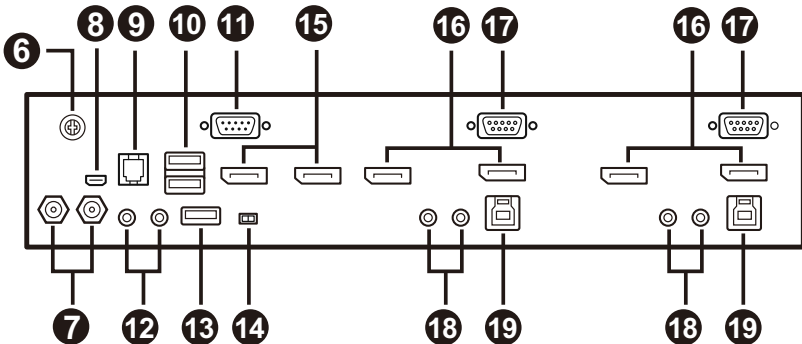

No.	Component	Description
Front View		
1	port LEDs	This panel contains LED icons that light to indicate mode and port status. The mode and port selection pushbuttons have three corresponding LED icons that light to indicate status – KVM , Audio , and USB .

No.	Component	Description
2	mode selection pushbutton	<ul style="list-style-type: none"> ◆ This pushbutton allows you to cycle through the four focus modes – complete, KVM, audio, and USB. ◆ Press and hold mode selection pushbutton before powering on to enter firmware upgrade mode. See <i>The Firmware Upgrade Utility</i>, page 43.
3	port selection pushbuttons	<p>For manual port selection (see <i>Manual Switching</i>, page 13):</p> <ul style="list-style-type: none"> ◆ Press a port selection pushbutton for less than two seconds to bring the KVM, USB hub, and audio focus to the computer attached to its corresponding port. ◆ Press a port selection pushbutton twice to bring the audio focus to the computer attached to its corresponding port. ◆ Press a port selection pushbutton for longer than two seconds to bring only the KVM focus to the computer attached to its corresponding port. ◆ Press port selection pushbutton 1 and 2 simultaneously for 2 seconds to start Auto Scan Mode (see <i>Hotkey Setting Mode</i>, page 18).
4	audio jacks	<p>Your main console microphone and speakers plug in here.</p> <p>Note: The microphone and speakers plugged into the front panel have priority over those plugged into the rear panel.</p>
5	USB 3.1 Gen 1 Type-A port	<p>USB peripherals (printers, scanners, drives etc.) plug into this port. This USB 3.1 Gen 1 port features 5 Gbps data transfer rates for compatible USB peripherals.</p>

Rear View

6	grounding terminal	The grounding wire used to ground the switch attaches here.
7	power jacks	The power adapter cable plugs into this lockable jack.

Rear View (Console Ports Section)

8	USB Micro-B port (firmware upgrade)	Use a USB Micro-B to USB Type-A cable connect the CS1942ATC to a PC for firmware upgrade.
9	RJ-11 port	The optional remote port selector plugs in here. To use a remote port selector for port selection, make sure to slide the primary / secondary switch to the p position. See page 7.

No.	Component	Description
10	USB 2.0 Type-A ports	The cables from your keyboard and mouse plug in here. Each connector is marked with an appropriate icon to indicate itself.
11	RS-232 serial port	The RS-232 serial device such as a printer plugs in here.
12	audio jacks	The cables from your microphone and speakers plug in here. Each connector is marked with an appropriate icon to indicate itself.
13	USB 3.1 Gen 1 Type-A port	USB peripherals (printers, scanners, drives etc.) plug into this port. This USB 3.1 Gen 1 port features 5 Gbps data transfer rates for compatible USB peripherals.
14	primary / secondary switch	Slide the primary / secondary switch to the s position to allow the KVM switch to receive RS-232 commands via an RJ45-to-DB9 cable. Please see <i>RS-232 Operation</i> , page 29. Slide the primary / secondary switch to the p position if the remote port selector is connected to RJ-11 port for port selection.
15	DisplayPort out	The cable from your monitor plugs in here. Each connector is marked with an appropriate icon to indicate itself.

Rear View (KVM Ports Section)

16	DisplayPort in	The monitor cables that link the switch to your computers plug in here. Each KVM port section is comprised of a microphone jack, speaker jack, USB Type-B port, RS-232 port, and a DisplayPort connector.
17	RS-232 serial ports	The RS-232 cables that link the switch to your computers plug in here. Each KVM port section is comprised of a microphone jack, speaker jack, USB Type-B port, RS-232 port, and a DisplayPort connector.
18	audio jacks	The audio cables that link the switch to your computers plug in here. Each KVM port section is comprised of a microphone jack, speaker jack, USB Type-B port, RS-232 port, and a DisplayPort connector.
19	USB Type-B ports	The USB Type-A to USB Type-B cables that link the switch to your computers plug in here. Each KVM port section is comprised of a microphone jack, speaker jack, USB Type-B port, RS-232 port, and a DisplayPort connector.

This Page Intentionally Left Blank

Chapter 2

Hardware Setup



1. Important safety information regarding the placement of this device is provided on page 51. Please review it before proceeding.
2. To prevent damage to your installation from power surges or static electricity. It is important that all connected devices are properly grounded.
3. Make sure that power to all the devices you will be installing has been turned off. You must unplug the power cords of any computers that have the Keyboard Power On function.
4. Please operate the device with caution when under high environmental temperatures, as the surface of the device may become overheated under such conditions. For instance, the surface temperature of the device may reach 70 °C (158 °F) or higher when the environmental temperature reaches close 50 °C (122 °F).

Cable Connections

To set up your installation, refer to the installation diagram on the following page (the numbers in the diagram on page 11 correspond to the steps below), and do the following:

1. Ground the CS1942ATC by connecting one end of the a grounding wire to the grounding terminal and the other end to a suitable grounded object.

Note: Do not omit this step. Proper grounding helps to prevent damage to the unit from power surges or static electricity.

2. Connect your USB keyboard and USB mouse to the unit's USB 2.0 Type-A ports.
3. Connect your DisplayPort-enabled displays to the unit's DisplayPort output ports.

4. Connect your primary microphone and speakers to the unit's audio jacks located on the front panel. Optionally, connect your secondary microphone and speakers to the unit's audio jacks located on the rear panel.

Note: The microphone and speakers connected into the front panel have priority over those connected into these jacks.

5. Using the provided cables, connect the audio, video, RS-232, and USB ports of up to 2 PCs to the KVM ports section on the KVM switch.

Note: Make sure that all the connectors from one PC are connected to the same KVM ports section (all in CPU1, all in CPU2, etc.).

6. (Optional) Connect your USB peripherals to the unit's USB 3.1 Gen 1 Type-A ports.
7. (Optional) Connect your RS-232 serial devices such as a printer to the unit's RS-232 serial port from the console ports section.
8. (Optional) To use a remote port selector for port selection, plug its cable into the RJ-11 port.

Note:

- ◆ To purchase a remote port selector for CS1942ATC, contact your ATEN dealer for more information.
 - ◆ To use a remote port selector for port selection, make sure to slide the primary / secondary switch to the p position. See page 7.
-

9. Connect the power adapters to the unit's power jacks. Now the CS1942ATC is powered on.

Note: We recommend connecting both power adapters to the unit for power redundancy.

10. Power on the computers, displays, and the other connected devices.

Note:◆ By default, the CS1942ATC switches to the first computer that is powered on.

- ◆ We recommend that the total video cable length from the PC to the console monitor cannot exceed 3 meters.

- ♦ Choosing high quality video cable ensures 4K UHD (3840x2160 @ 60 Hz) or 4K DCI (4096x2160 @ 60Hz) resolutions can be achieved.
- ♦ Make sure the computers, displays, and other connected devices are also properly grounded.

Installation Diagram

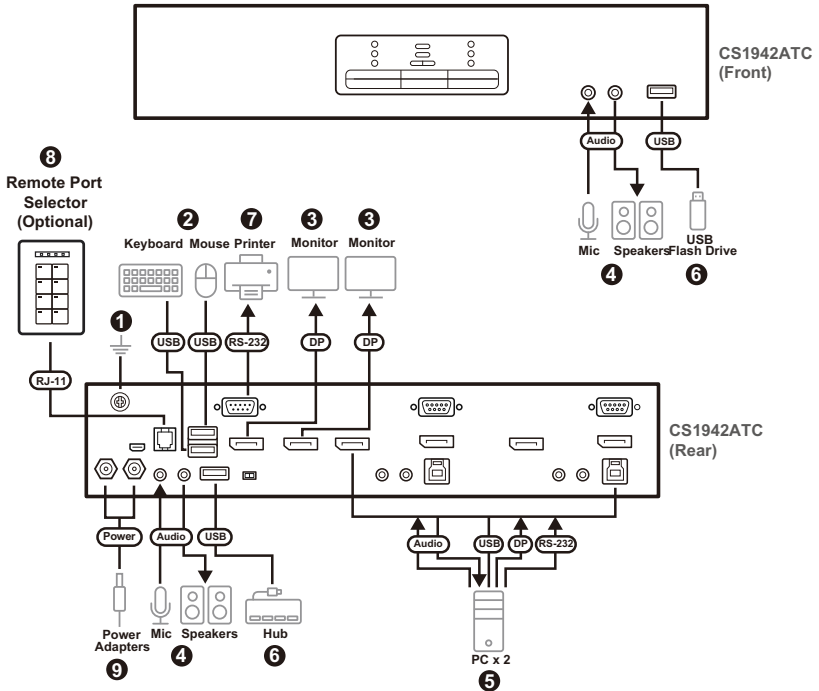

This Page Intentionally Left Blank

Chapter 3

Basic Operation

Port Switching

There are five methods to switch between the computers: Manual – by pressing the port selection pushbuttons on the front panel; Mouse – by double-clicking the scroll wheel; Hotkey – by entering key combinations on the keyboard; RS-232 Commands – by entering the correct command and control; and (optional) Remote Port Selector – by pressing the remote port selector connected to the unit's RJ-11 port.

Manual Switching

For manual port selection:

- ◆ Press and release a port selection pushbutton to bring the KVM (keyboard, video, and mouse) focus, plus the USB, RS-232, and Audio focus, to the computer attached to its corresponding port.
- ◆ Press and hold a port selection pushbutton for more than 2 seconds to bring the KVM focus to the computer attached to its corresponding port. The USB, RS-232, and Audio focus does not change – they stay with the port that they are already on.
- ◆ Press a port selection pushbutton twice to bring the audio focus to the computer attached to its corresponding port.
- ◆ Press and hold port selection pushbutton 1 and 2 for more than 2 seconds to start Auto Scan Mode (see page 18 for details).
- ◆ Press and release either port selection pushbutton to stop Auto Scan Mode. The KVM focus goes to the computer attached to the corresponding port of the switch you pressed.
- ◆ Press and hold port selection pushbutton 3 and 4 for more than 2 seconds to start keyboard and mouse reset, see *USB Reset*, page 21.

Note: This function is only applicable to CS1942ATC.

Mouse Switching

For mouse port selection: Double-click the scroll wheel of your USB mouse to cycle through the ports.

-
- Note:** 1. Mouse switching is only supported by USB 3-key scroll wheel mice.
2. Mouse switching is disabled by default. See *Mouse Port Switching*, page 22, to enable mouse switching.
 3. Mouse switching is only supported when Mouse Emulation is enabled.
-

RS-232 Commands

For RS-232 port selection: Enter the correct command and control to switch port, see *RS-232 Operation*, page 29.

Remote Port Selector (Optional)

For remote port selector port selection: Press and release a port selection pushbutton to bring the KVM focus, plus the USB and Audio focus, to the computer attached to its corresponding port.

Hot Plugging

The CS1942ATC supports USB hot plugging – components can be removed and added back into the installation by unplugging their cables from the USB hub ports without the need to shut the unit down.

Powering Off and Restarting

If it becomes necessary to power off the switch, before powering it back on, you must do the following:

1. Shut down all the computers that are attached to the switch.
2. Unplug the switch's power adapter cable.
3. Wait 10 seconds, then plug the switch's power adapter cable back in.
4. Once the switch is powered up, power on the computers.

Port ID Numbering

Each KVM port section on the switch is assigned a port number 1 or 2. The port numbers are marked (CPU 1, CPU 2, etc.) on the rear panel of the switch.

The Port ID of a computer is derived from the KVM port number it is connected to. For example, a computer connected to KVM port 2 has a Port ID of 2.

The Port ID is used to specify which computer gets the KVM, USB peripheral, and audio focus with the Hotkey port selection method (See *The n stands for the computer's Port ID number (1 and 2)*. See *Port ID Numbering, page 15*. Replace the *n* with the appropriate Port ID when using the hotkey port switching., page 17 for details).

Alternative Manual Port Selection Settings

When Hotkey Setting Mode has been activated (page 25), pressing [S] will invoke the alternative front panel pushbutton manual port selection functions, as explained below:

- ◆ Press a port selection pushbutton once to bring only the KVM focus to the computer attached to its corresponding port.
- ◆ Press a port selection pushbutton twice to bring the audio focus to the computer attached to its corresponding port.
- ◆ Press and hold a port selection pushbutton for more than 2 seconds to bring the KVM, audio, RS-232, and USB focus to the computer attached to its corresponding port.
- ◆ Press and hold port selection pushbuttons 1 and 2 for more than 2 seconds to start Auto Scan Mode, see page 18 for details.

This Page Intentionally Left Blank

Chapter 4

Hotkey Operation

The switch provides an extensive, easy-to-use, hotkey function that makes it convenient to control and configure your KVM installation from the keyboard.

Hotkey Port Switching

All port switches begin with tapping the **[Ctrl] + [n]**. The **n** stands for the computer's Port ID number 1 and 2. See *Port ID Numbering*, page 15. Replace the **n** with the appropriate Port ID when using the hotkey port switching. The tables below describe the actions that each key combination performs.

Cycling Through the Ports

Hotkey	Action
[Ctrl] [Enter]	Brings the KVM, USB hub, RS-232, and audio focus from the port that currently has the KVM focus to the next port on the installation (1 to 2; 2 to 1). Example: <ol style="list-style-type: none">1. Press [Ctrl]2. Press [Enter].

Going Directly to a Port

Hotkey	Action
[Ctrl] [n]	Brings the KVM, USB hub, RS-232, and audio focus to the computer attached to the port corresponding to the specified Port ID (1 and 2). Example: <ol style="list-style-type: none">1. Press [Ctrl]2. Press [n].

Note: The **n** stands for the computer's Port ID number (1 and 2). See *Port ID Numbering*, page 15. Replace the **n** with the appropriate Port ID when using the hotkey port switching.

Hotkey Setting Mode

Hotkey Setting Mode is used to set up your switch's configuration. All operations begin with invoking Hotkey Setting Mode (HSM). After invoking HSM, use the hotkeys listed on the pages that follow to configure the switch. A summary of the HSM hotkeys is provided on page 25.

Invoking HSM

To invoke HSM, do the following:

1. Press and hold down the [**Num Lock**] key.
2. Press and release the [-] key.
3. Release the [**Num Lock**] key.

-
- Note:**
1. There is an alternate key combination to invoke HSM, see page 19 for details.
 2. The minus key must be released within one half-second, otherwise Hotkey invocation is canceled.
-

When HSM is active, the Caps Lock and Scroll Lock LEDs flash in succession. They stop flashing and revert to normal status when you exit HSM.

Ordinary keyboard and mouse functions are suspended – only Hotkey-compliant keystrokes and mouse clicks (described in the sections that follow), can be input.

At the conclusion of some hotkey operations, you automatically exit HSM mode. With some operations, you must exit manually. To exit HSM manually, press the [**Esc**] key, or the [**Spacebar**].

Alternate HSM Invocation Keys

An alternate set of HSM invocation keys is provided in case the default set conflicts with programs running on the computers.

To switch to the alternate HSM invocation set, do the following:

1. Invoke HSM (see page 18).
2. Press and release the **[H]** key.

Note: The HSM invocation keys become the **[Ctrl]** and **[F12]** key (instead of **[Num Lock]** and **[-]**). This procedure is a toggle. Repeat to revert to the original setting.

Buzzer Control

To toggle the buzzer on or off, do the following:

1. Invoke HSM (see page 18).
2. Press and release **[B]**.

This procedure is a toggle. Repeat to revert to the original setting.

Power Redundancy Indication

To toggle the power redundancy indication on or off, do the following:

1. Invoke HSM (see page 18).
2. Press and release **[P]**.

This procedure is a toggle. Repeat to revert to the original setting.

Note:

- ◆ For this function to work, you will first need to enable the Buzzer Control, see *Buzzer Control*, page 19.
 - ◆ When enabled, the buzzer sounds and the front panel LEDs flash to indicate that there are no two power adapters connected and two power supplies detected by the CS1942ATC.
 - ◆ When disabled, the buzzer will not sound even if both power adapters are connected and detected by the CS1942ATC.
-

Pause Power Redundancy Indication

To pause the power redundancy indication, do the following:

1. Invoke HSM (see page 18).
2. Press and release [O].

Note:

- ◆ This function can be used when the Buzzer Control (see *Buzzer Control*, page 19) and Power Redundancy (see *Power Redundancy Indication*, page 19)
 - ◆ You can pause the power redundancy indication for 10 minutes. If both power adapters are connected and detected by the CS1942ATC within the 10 minutes duration, the Power Redundancy and Pause Power Redundancy will cancel automatically.
-

Keyboard Operating Platform

The switches' default port configuration is for a PC-compatible keyboard operating platform. If your console uses a PC-compatible keyboard and you have a Mac attached to a port, for example, you can change the port's keyboard operating platform configuration so that the PC-compatible keyboard emulates the Mac keyboard. The procedure is as follows:

1. Bring the KVM focus to the port you want to set.
2. Invoke HSM (see page 18).
3. Press and release the appropriate Function key (see table below). After completing this procedure, you automatically exit HSM.

Function Key	Operation
[F1]	To set the keyboard/mouse to use SPC mode so that it can work under special operating systems as a standard (104 key) keyboard/mouse.
[F2]	Enables Mac keyboard emulation, see <i>Mac Keyboard</i> , page 27 for details.
[F3]	Enables Sun keyboard emulation, see <i>Sun Keyboard</i> , page 28.
[F10]	Enables Windows keyboard emulation.

List Switch Settings

To see a listing of the current switch settings, do the following:

1. Open a text editor or word processor and place the cursor in the page window.
2. Invoke HSM (see page 18).
3. Press and release **[F4]** to display the settings.

USB Reset

If the USB loses focus and needs to be reset, do the following:

1. Invoke HSM (see page 18).
2. Press and release **[F5]**.

Keyboard Language

To change the keyboard language, do the following:

1. Invoke HSM (see page 18).
2. Press **[F6]** *[nn]* **[Enter]**.

Note: *nn* is a two-digit number that represents the keyboard language code (US English: 33; French: 08; Japanese: 15; German: 09).

Firmware Upgrade Mode

To set the switch to Firmware Upgrade Mode, do the following:

1. Invoke HSM (see page 18).
2. Key in: **[U]** **[P]** **[G]** **[R]** **[A]** **[D]** **[E]**.
3. Press **[Enter]**. The front panel LEDs flash to indicate the upgrade has started.

Note: To exit Firmware Upgrade Mode, you must power off the switch.

Restore Default Settings

To reset the switch to its default hotkey settings, do the following:

1. Invoke HSM (see page 18).
2. Press **[R]** **[Enter]**.

Note: All hotkey settings return to the factory default values (See *Hotkey Default Settings*, page 57).

Alternative Manual Port Selection

To toggle between the default and the alternative front panel pushbutton manual port selection settings, do the following:

1. Invoke HSM (see page 18).
2. Press **[S]**.

This procedure is a toggle. Repeat to revert to the original setting. See *Alternative Manual Port Selection Settings*, page 15, for more information.

Mouse Emulation

To toggle between mouse emulation enabled and disabled, do the following:

1. Invoke HSM (see page 18).
2. Press **[M]**.

This procedure is a toggle. Repeat to revert to the original setting

Mouse Port Switching

Mouse Port Switching allows you to use the mouse wheel button (clicked twice) to switch ports. For Mouse Port Switching to work, Mouse Emulation (above) must be enabled. To toggle between mouse port switching enabled and disabled, do the following:

1. Invoke HSM (see page 18).
2. Press **[W]**.

This procedure is a toggle. Repeat to revert to the original setting.

Note: This feature is only supported by USB 3-key scroll wheel mice. The default setting is disabled. This feature is only supported when mouse emulation is also enabled. See *Mouse Emulation*, above.

Keyboard Emulation

The console keyboard port emulation/bypass feature supports most gaming/multimedia keyboards. The default setting is enabled. To disable, do the following:

1. Invoke HSM (see page 18).
2. Press **[N]**.

This procedure is a toggle. Repeat to revert to the original setting.

Note: When keyboard emulation is disabled, the [M], [Q], [W], [F2], [F4], [F5], [F6], and [F10] hotkey operations are disabled.

Power on Detection

With Power on Detection, if the focus computer is powered off, the switch will automatically switch to the next powered-on computer. Power on Detection can be enabled or disabled. The default setting is enabled. To disable Power on Detection, do the following:

1. Invoke HSM (see page 18).
2. Press and release **[E]**.

This procedure is a toggle. Repeat to revert to the original setting.

N-Key Rollover Keyboard Supporting Function

To enable/disable N-key rollover keyboard supporting function, do the following:

1. Invoke HSM (see page 18).
2. Press **[K] [Enter]**.

Note: If you encounter any problem when using the BIOS when your computer is starting up, please turn off the N-Key rollover keyboard supporting function and then try again.

EDID Mode

Extended Display Identification Data (EDID) is a data that contains a display's basic information and is used to communicate with the video source. The EDID mode allows you to set a pre-configured EDID for your connected display. To select a EDID mode, do the following:

1. Invoke HSM (see page 18).
2. Press **[V]**.
3. Press and release the appropriate Function key (see the table below).
4. Press **[Enter]**

Function Key	Operation
1	Sets the monitor EDID.
2	Sets the FHD mode EDID 1920 x 1080 @ 60 Hz.
3	Sets the 2K mode EDID 2048 x 2048 @ 60 Hz.
4	Sets the 4K UHD mode EDID 3840 x 2160 @ 60 Hz.
5	Sets the 4K DCI mode EDID 4096 x 2160 @ 60 Hz.

HSM Summary Table

After invoking HSM (see page 18), key in one of the following keys to perform the corresponding function:

Key	Function
[B]	Toggles the buzzer on and off.
[E]	Enables/disables the power on detection feature.
[H]	Toggles between the default and alternate HSM invocation keys.
[K] [Enter]	Enables/disables N-key rollover keyboard supporting function.
[M]	Toggles between mouse emulation enable and disable.
[N]	Enables/disables keyboard emulation.
[P]	Enables/disables the power redundancy indication feature.
[O]	Pauses the power redundancy indication if the power redundancy indication is enabled.
[R] [Enter]	Resets the hotkey settings to their default statuses.
[S]	Toggles between the default and alternative pushbutton operation settings.
[U][P][G][R][A][D][E] [Enter]	Invokes Firmware Upgrade Mode.
[V] [n] [Enter]	Sets the EDID mode for the KVM switch. <ul style="list-style-type: none"> ◆ n = 1, sets the monitor EDID. ◆ n = 2, sets the FHD mode EDID 1920 x 1080 @ 60 Hz. ◆ n = 3, sets the 2K mode EDID 2048 x 2048 @ 60 Hz. ◆ n = 4, sets the 4K UHD mode EDID 3840 x 2160 @ 60 Hz. ◆ n = 5, sets the 4K DCI mode EDID 4096 x 2160 @ 60 Hz.
[W]	Enables/disables mouse port switching









Key	Function
[F1]	Allows the keyboard and mouse to work under special operating systems as a standard (104 key) keyboard/ mouse.
[F2]	Enables Mac keyboard emulation.
[F4]	Prints the switch's current settings via a text editor or word processor.
[F5]	Performs a reset on all USB devices.
[F6] [nn] [Enter]	Sets the keyboard language. <i>nn</i> represents one of the following keyboard language codes: US English: 33; French: 08; Japanese: 15; German: 09.
[F10]	Enables Windows keyboard emulation.

Chapter 5

Keyboard Emulation

Mac Keyboard







PC-compatible (101/104 key) keyboards can emulate the functions of a Mac keyboard. The emulation mappings are listed in the table below.

PC Keyboard	Mac Keyboard
[Shift]	Shift
[Ctrl]	Ctrl
	
[Ctrl] [1]	
[Ctrl] [2]	
[Ctrl] [3]	
[Ctrl] [4]	
[Alt]	Alt
[Print Screen]	F13
[Scroll Lock]	F14
	=
[Enter]	Return
[Backspace]	Delete
[Insert]	Help
[Ctrl] 	F15

Note: When using key combinations, press and release the first key (Ctrl), then press and release the activation key.

Sun Keyboard

The PC compatible (101/104 key) keyboard can emulate the functions of the Sun keyboard when the control key [Ctrl] is used in conjunction with other keys. The corresponding functions are shown in the table below.

PC Keyboard	Sun Keyboard
[Ctrl] [T]	Stop
[Ctrl] [F2]	Again
[Ctrl] [F3]	Props
[Ctrl] [F4]	Undo
[Ctrl] [F5]	Front
[Ctrl] [F6]	Copy
[Ctrl] [F7]	Open
[Ctrl] [F8]	Paste
[Ctrl] [F9]	Find
[Ctrl] [F10]	Cut
[Ctrl] [1]	
[Ctrl] [2]	
[Ctrl] [3]	
[Ctrl] [4]	
[Ctrl] [H]	Help
	Compose
	

Note: When using key combinations, press and release the first key (Ctrl), then press and release the activation key.

Chapter 6

RS-232 Operation

Overview

The CS1942ATC's built-in bi-directional RS-232 serial interface allows system control through a high-end controller or PC. RS-232 serial operations in a CS1942ATC installation are managed via HyperTerminal sessions on systems that are running Windows. In order to use this feature to send commands to the CS1942ATC, you must first download and install a HyperTerminal application.

Setup

Install a HyperTerminal application on a computer that is not part of the installation, which will be used to control the switch via the RS-232 connection. HyperTerminal applications can be download from the Internet, and many operating systems are embedded with HyperTerminal applications.

Hardware Connection

Use a RJ-11 to DB-9 serial adapter (LIN5-04A2-J11G) to connect a computer's serial port to the serial port on the CS1942ATC and slide the primary / secondary switch to p position, as shown below:

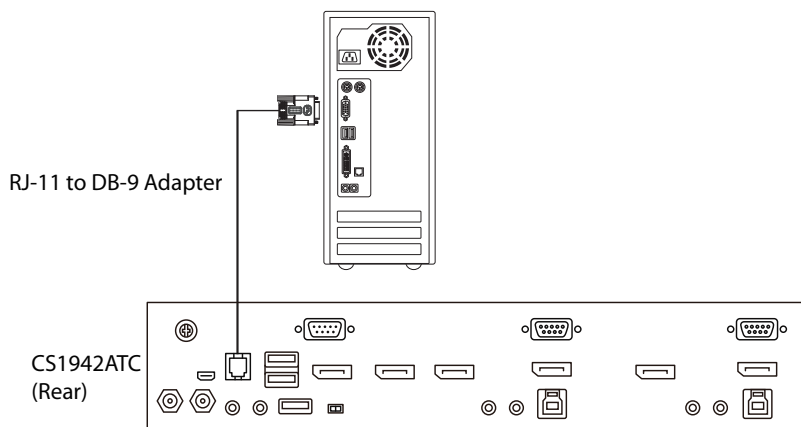

RS-232 Pin Assignments

Pin assignments for the CS1942ATC's rear DCC Port that is used for connecting to a serial terminal are given in the table, below:

Note: This RJ-11 female connector is 4P4C.

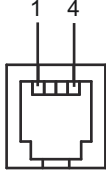
Pin	Assignment	
1	TXD: Transmit Data	 <p>The diagram shows a standard RJ-11 female connector. It has a rectangular shape with a notch on the right side. There are four pins on the top edge. The first pin from the left is labeled '1' and the fourth pin from the left is labeled '4'. The pins are arranged in a staggered pattern.</p>
2	RXD: Receive Data	
3	N/A	
4	GND: Signal Ground	

RJ-11 Female

Console Login - HyperTerminal

Once a physical connection from the computer to the CS1942ATC has been made, you can establish a HyperTerminal session using the instructions below.

1. Open the *HyperTerminal* application, and configure the port settings for COM1 port, then click **OK**.

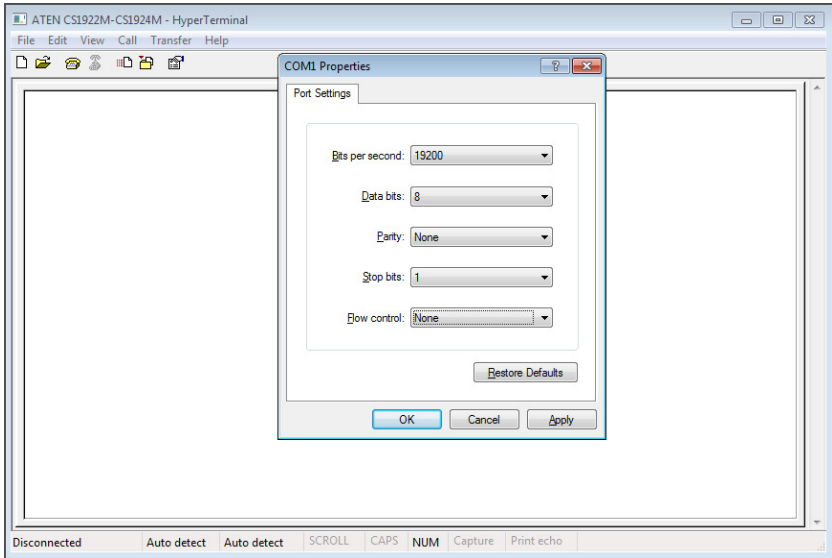

Bits per Second: **19200**, Data Bits: **8**, Parity: **None**, Stop bits: **1**, Flow Control: **None**.

2. After configuring the port settings you must enable serial control on the switch by typing the command: **Open + [Enter]**.

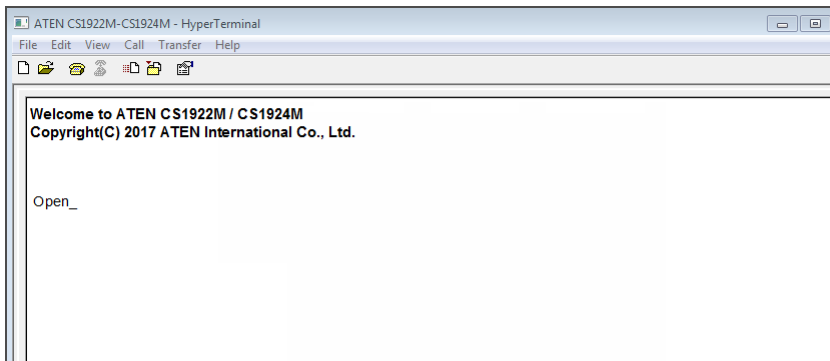

RS-232 Commands

After you login via HyperTerminal (see page 31) use the instructions below to send RS-232 commands to control the switch from the computer.

When RS-232 control is enabled via the **Open + [Enter]** command, the CS1942ATC's front panel pushbuttons, mouse switching and hotkeys will be disabled, until the serial connection is closed.

For detailed information about the controls listed in this guide, please refer to the CS1942ATC user manual.

Verification

After entering a command, a verification message appears, as shown below, at the end of the command line, as follows:

Response Message	Description
Command OK	Command or parameter is correct.
Command incorrect	Command or parameter is incorrect.

With all commands in the sections that follow:

- ◆ Each command string can be separated with a space.
- ◆ The [Enter] command can be replaced with the ASCII code: 0x0D0A

Open / Close

The *Open* and *Close* commands allows you to start and end the link between the computer sending RS-232 commands and the CS1942ATC. When the link is open, the CS1942ATC only accepts RS-232 commands and will not respond to front panel pushbuttons, mouse switching and hotkeys – until the link is closed. The link starts with the *open* command and ends with the *close* command or after 2 minutes if no command is sent. The default value is close.

Use the **Formula** - to set **Parameters** - to create a **Command**.

Formulas:

Command + [Enter]

Parameters:

Command	Description
open	Open RS-232 Link Command
close	Close RS-232 Link Command

Enter	Description
Enter	Enter and send out command

Open/Close RS-232 Link Command

The available formulas for the Open/Close RS-232 Link commands are as follows:

1. Command + [Enter]

For example, to open the RS-232 link between the computer and CS1942ATC, type the following:

open [Enter]

2. Command + [Enter]

For example, to close the RS-232 link between the computer and CS1942ATC, type the following:

close [Enter]

Switch Port

The *Switch Port* command allows you to switch ports. The default port is 01.

Use the **Formula** - to set **Parameters** - to create a **Command**.

Formula:

Command + Control + [Enter]

Parameters:

Command	Description
sw	Switch Port Command

Control	Description
ixx	Input Port Number x= 01~02 (Default: 01) Example: i02

Enter	Description
Enter	Enter and send out command

Switch Port Commands

Some available formulas for the Switch Port commands are as follows:

1. Command + Control + [Enter]

For example, to switch to port 2, type the following:

sw i02 [Enter]

Note: The **Control** command can be skipped and the default value will be used.

Set Baud Rate

The *Set Baud Rate* command allows you to configure the baud rate setting for the serial port connection. The default baud rate is 19200.

Use the **Formula** - to set **Parameters** - to create a **Command**.

Formula:

Command + Control + [Enter]

Parameters:

Command	Description
baud	Baud Rate Command
Control	Description
19200	Set baud rate to 19200
38400	Set baud rate to 38400
9600	Set baud rate to 9600
Enter	Description
Enter	Enter and send out command

Set Baud Rate Commands

Some available formulas for the Set Baud Rate commands are as follows:

1. Command + Control + [Enter]

For example, to set the baud rate to 19200, type the following:

baud 19200 [Enter]

Keyboard Language Layout

The *Keyboard Language Layout* command allows you to change the keyboard language layout. The default language is English.

Use the **Formula** - to set **Parameters** - to create a **Command**.

Formula:

Command + Control + [Enter]

Parameters:

Command	Description
layout	Keyboard Language Layout Command

Control	Description
en	Change the keyboard language layout to English
fr	Change the keyboard language layout to French
jp	Change the keyboard language layout to Japanese
ge	Change the keyboard language layout to German

Enter	Description
Enter	Enter and send out command

Keyboard Language Layout Commands

Some available formulas for Keyboard Language Layout commands are as follows:

1. Command + Control + [Enter]

For example, to change the keyboard language layout to Japanese, type the following:

layout jp [Enter]

2. Command + Control + [Enter]

For example, to change the keyboard language layout to French, type the following:

layout fr [Enter]

Hotkey Setting

The *Hotkey Setting* command allows you to change the hotkey used to invoke the HSM (Hotkey Setting Mode). The default hotkey is [Num Lock] + [-].

Use the **Formula** - to set **Parameters** - to create a **Command**.

Formulas:

Command + Control + [Enter]

Parameters:

Command	Description
hotkey	Hotkey Setting Command
Control	Description
num	Change the HSM invoke key to: [Num Lock] + [-]
f12	Change the HSM invoke key to: [Ctrl] + [F12]
Enter	Description
Enter	Enter and send out command

Hotkey Setting Commands

Some available formulas for Hotkey Setting commands are as follows:

1. Command + Control + [Enter]

For example, to change the HSM invoke key to [Num Lock] + [-], type the following:

hotkey num [Enter]

2. Command + Control + [Enter]

For example, to change the HSM invoke key to [Ctrl] + [F12], type the following:

hotkey f12 [Enter]

USB Reset

The *USB Reset* command allows you to reset the USB connection. The default USB reset setting is off.

Use the **Formula** - to set **Parameters** - to create a **Command**.

Formulas:

Command + Control + [Enter]

Parameters:

Command	Description
usbreset	USB Reset Command

Control	Description
on	Enable USB reset connection

Enter	Description
Enter	Enter and send out command

USB Reset Command

The available formula for the USB Reset command is as follows:

1. Command + Control + [Enter]

For example, to reset the USB connection, type the following:

usbreset on [Enter]

Restore Default Settings

The *Restore Default Settings* command allows you to reset all of the settings back to the default. The default setting is off.

Use the **Formula** - to set **Parameters** - to create a **Command**.

Formulas:

Command + Control + [Enter]

Parameters:

Command	Description
reset	Restore Default Settings Command
Control	Description
on	Enable restore default values
Enter	Description
Enter	Enter and send out command

Restore Default Value Command

The available formula for the Restore Default Settings command is as follows:

1. Command + Control + [Enter]

For example, to restore all CS1942ATC settings back to the default, type the following:

reset on [Enter]

Firmware Upgrade

The *Firmware Upgrade* command allows you to enable the firmware upgrade mode. The default setting is off.

Use the **Formula** - to set **Parameters** - to create a **Command**.

Formulas:

Command + Control + [Enter]

Parameters:

Command	Description
upgrade	Firmware Upgrade Command

Control	Description
on	Enable firmware upgrade mode

Enter	Description
Enter	Enter and send out command

Firmware Upgrade Command

The available formula for the Firmware Upgrade command is as follows:

1. Command + Control + [Enter]

For example, to enable firmware upgrade mode, type the following:

upgrade on [Enter]

KVM Status

The *KVM Status* command allows you to display read-only information about the switches' current configuration status. The default setting is off.

Use the **Formula** - to set **Parameters** - to create a **Command**.

Formulas:

Command + Control + [Enter]

Parameters:

Command	Description
status	KVM Status Command
Control	Description
on	Enable KVM status
Enter	Description
Enter	Enter and send out command

KVM Status Command

The available formula for the KVM Status command is as follows:

1. Command + Control + [Enter]

For example, to display the CS1942ATC's configuration status, type the following:

status on [Enter]

A message similar to the one below will then appear:

hotkey: [numlock]+[-] / [scrolllock],[scrolllock]

os setting: pc

keyboard emulation: enabled/disabled

keyboard layout: English

mouse emulation: enabled/disabled

monitor re-detection: enabled/disabled

This Page Intentionally Left Blank

Chapter 7

The Firmware Upgrade Utility

The Windows-based Firmware Upgrade Utility (FWUpgrade.exe) provides a smooth, automated process for upgrading the KVM switch's firmware. The Utility comes as part of a Firmware Upgrade Package that is specific for each device. Check the web site regularly to find the latest packages and information relating to them:

<http://www.aten.com/global/en/support-and-downloads/downloads/>

Before you Begin

1. From a computer that is not part of your KVM installation, go to our [Support & Downloads](#) site and choose the model name that relates to your device CS1942ATC to get a list of available Firmware Upgrade Packages.
2. Choose the Firmware Upgrade Package you want to install (usually the most recent), and download it to your computer.
3. Unzip the downloaded firmware upgrade package.
4. Power off the CS1942ATC. Connect a self-supplied USB Micro-B cable to a USB Type-A port on your computer.

Note: The USB Micro-B cable is not included in the package.

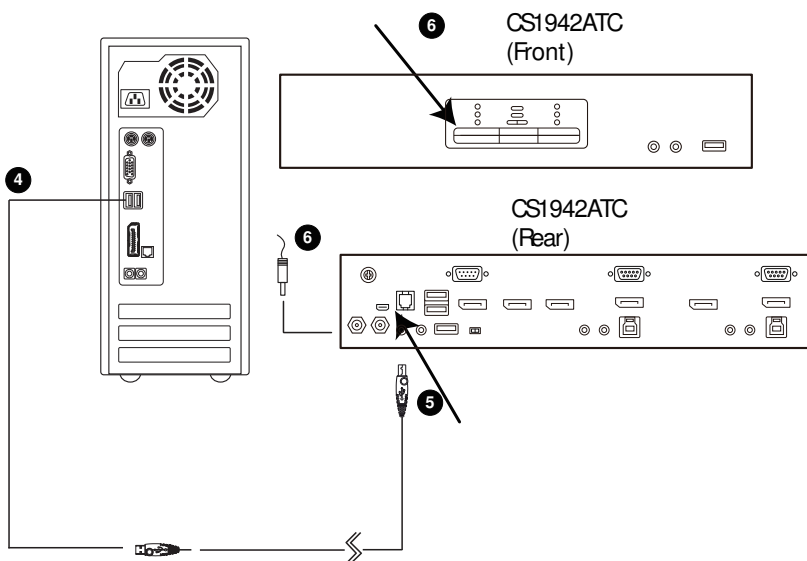

5. Connect the other end of a self-supplied USB Micro-B cable to the unit's USB Micro-B port.
6. Press and hold the mode selection pushbutton or remote port selector pushbutton 1. While you are holding the button, connect the power adapter to the CS1942ATC to enter Firmware Upgrade Mode. The front panel LEDs flash together to indicate Firmware Upgrade Mode is in effect.

Starting the Upgrade

To upgrade your firmware:

1. Run the downloaded Firmware Upgrade Package file – either by double clicking the file icon, or by opening a command line and entering the full path to it.

The *Firmware Upgrade Utility* Welcome screen appears:

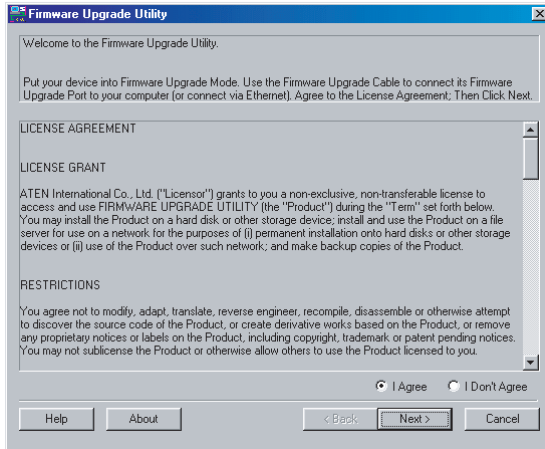

Note: The screens shown in this section are for reference only. The wording and layout of the actual screens put up by the Firmware Upgrade Utility may vary slightly from these examples.

2. Read the License Agreement (enable the *I Agree* radio button).

3. Click **Next** to continue. The Firmware Upgrade Utility main screen appears:

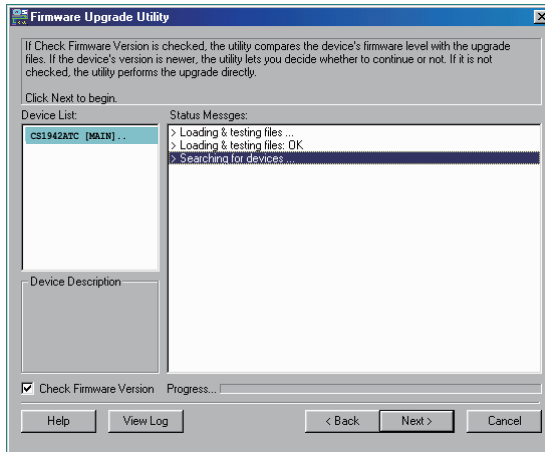

The Utility inspects your installation. All the devices capable of being upgraded by the package are listed in the *Device List* panel.

4. As you select a device in the list, its description appears in the Device Description panel.

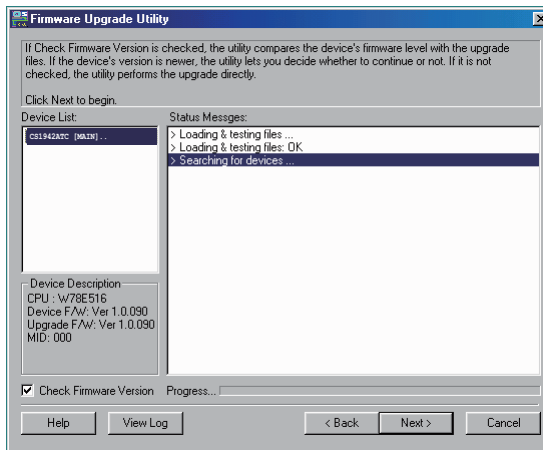

5. After you have made your device selection(s), Click **Next** to perform the upgrade.

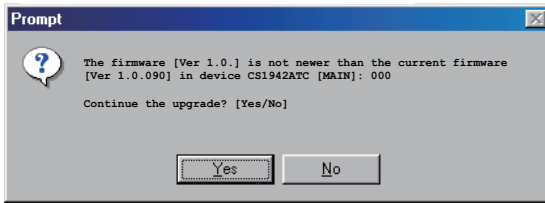

If you enabled *Check Firmware Version*, the Utility compares the device's firmware level with that of the upgrade files. If it finds that the device's version is higher than the upgrade version, it brings up a dialog box informing you of the situation and gives you the option to Continue or Cancel.

If you didn't enable *Check Firmware Version*, the Utility installs the upgrade files without checking whether they are a higher level, or not.

As the Upgrade proceeds, status messages appear in the Status Messages panel, and the progress toward completion is shown on the *Progress* bar.

Upgrade Succeeded

After the upgrade has completed, a screen appears to inform you that the procedure was successful:

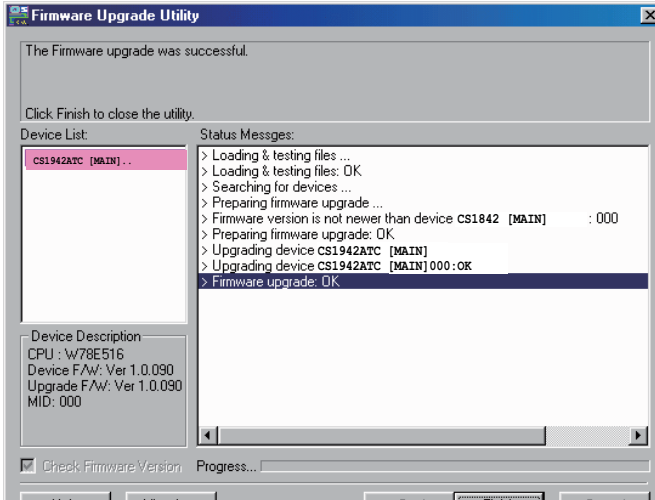

Click **Finish** to close the Firmware Upgrade Utility.

After a successful completion, the switches exit Firmware Upgrade Mode, and reset themselves.

Upgrade Failed

If the *Upgrade Succeeded* screen doesn't appear, it means that the upgrade failed to complete successfully, in which case you should do the following:

1. Power off the CS1942ATC by removing the power jack.
2. Invoke Firmware Upgrade Mode by holding down the *Mode Selection* pushbutton on the front panel (see *mode selection pushbutton*, page 6) and power on the CS1942ATC. The orange LEDs flash together.
3. Do the firmware upgrade procedure again.

This Page Intentionally Left Blank

Safety Instructions

- ◆ Read all of these instructions. Save them for future reference.
- ◆ This device is for indoor use only.
- ◆ Follow all warnings and instructions marked on the device.
- ◆ Do not place the device on any unstable surface (cart, stand, table, etc.). If the device falls, serious damage will result.
- ◆ Do not use the device near water.
- ◆ Do not place the device near, or over, radiators or heat registers.
- ◆ The device cabinet is provided with slots and openings to allow for adequate ventilation. To ensure reliable operation, and to protect against overheating, these openings must never be blocked or covered.
- ◆ The device should never be placed on a soft surface (bed, sofa, rug, etc.) as this will block its ventilation openings. Likewise, the device should not be placed in a built in enclosure unless adequate ventilation has been provided.
- ◆ Never spill liquid of any kind on the device.
- ◆ Unplug the device from the wall outlet before cleaning. Do not use liquid or aerosol cleaners. Use a damp cloth for cleaning.
- ◆ The device should be operated from the type of power source indicated on the marking label. If you are not sure of the type of power available, consult your dealer or local power company.
- ◆ Avoid circuit overloads. Before connecting equipment to a circuit, know the power supply's limit and never exceed it. Always review the electrical specifications of a circuit to ensure that you are not creating a dangerous condition or that one doesn't already exist. Circuit overloads can cause a fire and destroy equipment.
- ◆ To prevent damage to your installation, it is important that all devices are properly grounded.
- ◆ Do not allow anything to rest on the power cord or cables. Route the power cord and cables so that they cannot be stepped on or tripped over.
- ◆ Position system cables and power cables carefully; Be sure that nothing rests on any cables.

- ◆ Never push objects of any kind into or through cabinet slots. They may touch dangerous voltage points or short out parts resulting in a risk of fire or electrical shock.
- ◆ Do not attempt to service the device yourself. Refer all servicing to qualified service personnel.
- ◆ If the following conditions occur, unplug the device from the wall outlet and bring it to qualified service personnel for repair.
 - ◆ The power cord or plug has become damaged or frayed.
 - ◆ Liquid has been spilled into the device.
 - ◆ The device has been exposed to rain or water.
 - ◆ The device has been dropped, or the cabinet has been damaged.
 - ◆ The device exhibits a distinct change in performance, indicating a need for service.
 - ◆ The device does not operate normally when the operating instructions are followed.
- ◆ Only adjust those controls that are covered in the operating instructions. Improper adjustment of other controls may result in damage that will require extensive work by a qualified technician to repair.
- ◆ Do not connect the RJ-11 connector to a public telecommunication network.

Optional Remote Port Selector

Other than the port switching methods explained in Chapter 3 Basic Operation *Port Switching*, page 13, the 2XRT-0021G is also available for CS1942ATC to easily switch port. Please contact your ATEN dealer for more information.

Troubleshooting

Operation problems can be due to a variety of causes. The first step in solving them is to make sure that all cables are securely attached and seated completely in their sockets.

In addition, updating the product's firmware may solve problems that have been discovered and resolved since the prior version was released. If your product is not running the latest firmware version, we strongly recommend that you upgrade. See *The Firmware Upgrade Utility*, Chapter 6, for upgrade details.

Symptom	Possible Cause	Action
Erratic behavior.	Unit not receiving enough power.	Use a DC 5V power adapter if you are not already using one. If you are already using a power adapter, check that it matches the system specifications, and that it is plugged in and functioning properly.
	Keyboard and/or mouse need to be reset.	Unplug the cable(s) from the console port(s), then plug it/them back in.
	No connection to the computer.	Check the cable from the switch to the computer to make sure it is properly connected.
	KVM switch needs to be reset.	Power off all devices on the installation; power off the KVM switch; wait five seconds; then power up.
USB devices not responding.	USB ports need to be reset.	Unplug the device's USB cable from the USB port on the switch's rear panel, then plug it back in.
		Use the USB Reset hotkey combination (see page 21), to reset the USB ports.

Technical Support

Technical support is available both by email and online (with a browser over the web):

International

- ◆ For online technical support – including troubleshooting, documentation, and software updates: <http://support.aten.com>
- ◆ For telephone support, see *Telephone Support*, page iv:

North America

Email Support		support@aten-usa.com
Online Technical Support	Troubleshooting Documentation Software Updates	http://www.aten-usa.com/support
Telephone Support		1-888-999-ATEN ext 4988 1-949-428-1111

When you contact us, please have the following information ready beforehand:

- ◆ Product model number, serial number, and date of purchase.
- ◆ Your computer configuration, including operating system, revision level, expansion cards, and software.
- ◆ Any error messages displayed at the time the error occurred.
- ◆ The sequence of operations that led up to the error.
- ◆ Any other information you feel may be of help.

Specifications

Function		CS1942ATC	
Connections	Computer	2	
	Console	1	
Port Selection		Pushbuttons, Hotkey, Mouse*, RS-232 Commands, Remote Port Selector (Optional)	
Connectors	Console Ports	Keyboard	1 x USB Type-A Female (Black)
		Video	2 x DisplayPort Female (Black)
		Mouse	1 x USB Type-A Female (Black)
		Speakers	1 x 3.5 mm Mini Stereo Jack (Green; Front) 1 x 3.5 mm Mini Stereo Jack (Green; Rear)
		Mic	1 x 3.5 mm Mini Stereo Jack (Pink; Front) 1 x 3.5 mm Mini Stereo Jack (Pink; Rear)
		RS-232	1 x DB-9 Female
	KVM Ports	KB / Mouse	2 x USB 3.1 Gen 1 Type-B (Blue)
		Video	4 x DisplayPort Female (Black)
		Speakers	2 x 3.5 mm Mini Stereo Jack (Green)
		Mic	2 x 3.5 mm Mini Stereo Jack (Pink)
		RS-232	2 x DB-9 Female
	USB Hub		1 x USB 3.1 Gen 1 Type-A Female (Blue; Front) 1 x USB 3.1 Gen 1 Type-A Female (Blue; Rear)
	Remote Port Selector		1 x RJ-11 Female
	Power		2 x DC Jack
	Firmware Upgrade		1 x USB Micro-B Female
	Switches	Selected	3 x Pushbutton
	LEDs	KVM	2 (Orange)
USB Link		2 (Green)	
Audio		2 (Green)	
Emulation	Keyboard / Mouse	USB	
Video		4096 x 2160 @ 60 Hz	
Scan Interval		5 secs	
Power Consumption		DC12V:17.8W:148BTU	

Function		CS1942ATC
Environment	Operating Temp.	0–50° C
	Storage Temp.	-20–60° C
	Humidity	0–80% RH, Non-condensing
Physical Properties	Housing	Metal
	Weight	1.88 kg (4.14 lb)
	Dimensions (L x W x H)	33.50 x 16.10 x 6.55 cm (13.19 x 6.34 x 2.58 in)

* Port switching only works with 3-key USB mouse wheel in emulation mode.

Hotkey Default Settings

The hotkey factory default settings are as follows:

Setting	Default
Port Switching	[Ctrl] + [n] / [Ctrl] + [Enter]
Invoking HSM	[Number Lock] [-]
Keyboard Emulation	Enabled
Mouse Emulation	Enabled
Auto Scan Interval	5 Seconds
Mouse Wheel Switching	Disabled
Power On Detection	Enabled
Keyboard Language Layout	English
Specific PC Port Monitor Re-detection	Disabled
Beeper	Enabled
Keyboard Operating Platform	Windows
Port Switching Keys	Enabled

ATEN Standard Warranty Policy

Limited Hardware Warranty

ATEN warrants its hardware in the country of purchase against flaws in materials and workmanship for a Warranty Period of two [2] years (warranty period may vary in certain regions/countries) commencing on the date of original purchase. This warranty period includes the **LCD panel of ATEN LCD KVM switches**. For UPS products, the device warranty is two [2] years but battery is one [1] year. Select products are warranted for an additional year (see *A+ Warranty* for further details). Cables and accessories are not covered by the Standard Warranty.

What is covered by the Limited Hardware Warranty

ATEN will provide a repair service, without charge, during the Warranty Period. If a product is defective, ATEN will, at its discretion, have the option to (1) repair said product with new or repaired components, or (2) replace the entire product with an identical product or with a similar product which fulfills the same function as the defective product. Replaced products assume the warranty of the original product for the remaining period or a period of 90 days, whichever is longer. When the products or components are replaced, the replacing articles shall become customer property and the replaced articles shall become the property of ATEN.

To learn more about our warranty policies, please visit our website:

<http://www.aten.com/global/en/legal/policies/warranty-policy/>

© Copyright 2023 ATEN® International Co., Ltd.
Released: 2023-12-15

ATEN and the ATEN logo are registered trademarks of ATEN International Co., Ltd. All rights reserved. All other brand names and trademarks are the registered property of their respective owners.